

ADTSEA

American Driver & Traffic Safety Education Association

70th Annual Conference

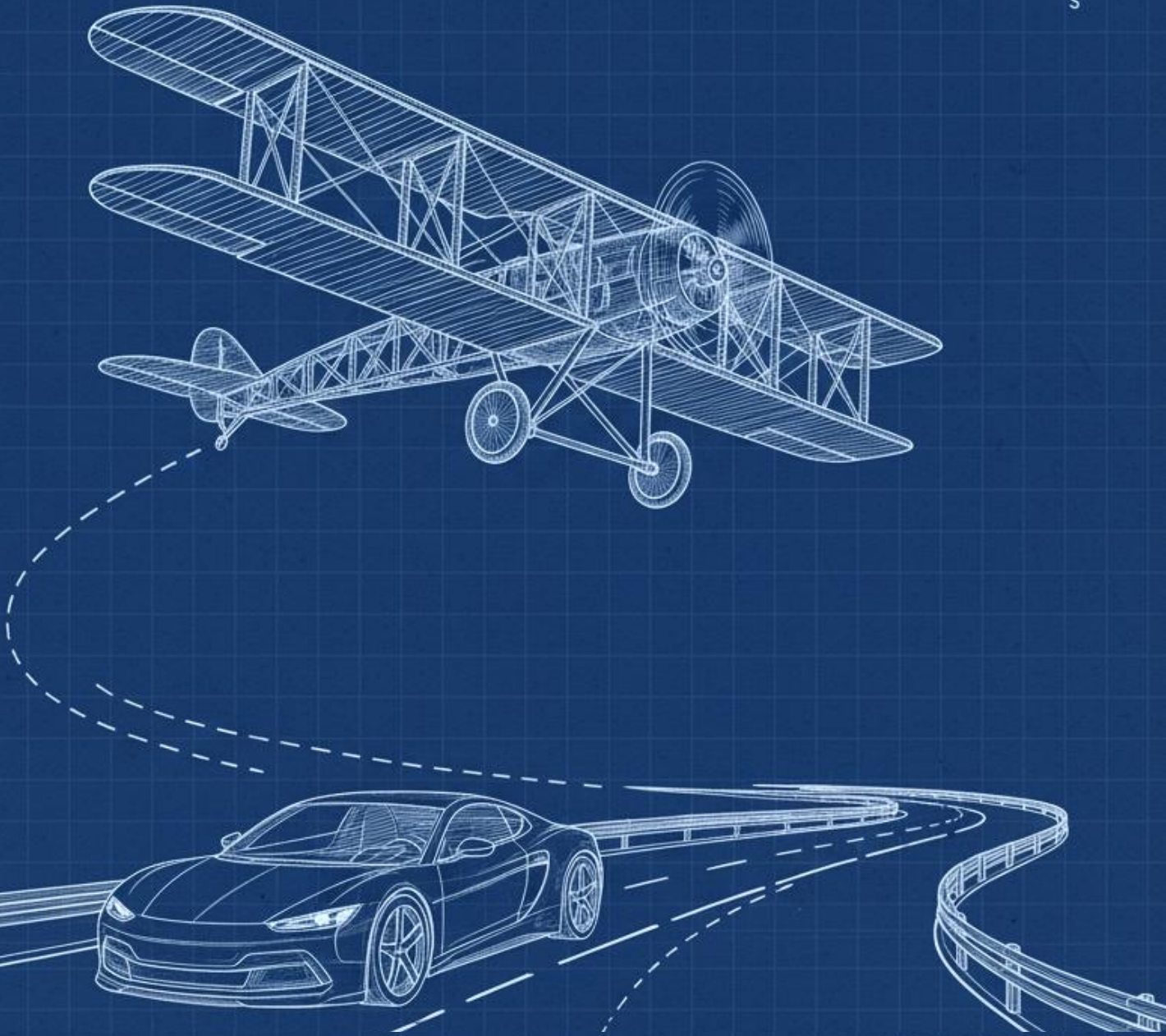

Project Title: **The Wright Way Forward:
Inspiring Safer Roads**

Date: **July 12-15, 2026**

**Draft Agenda
Version 1/20/2026**

A Special Thank You to Our 2026 ADTSEA National Conference Sponsors

Name Badge Sponsor



Attendee Shirt Sponsor

State and Program Administrators'
Workshop Lunch Sponsor

State and Regional Association
Leadership Roundtable
Dinner Co-Sponsors



Teacher Excellence Award & Luncheon
Sponsor



Tuesday Luncheon Sponsor



Tuesday Morning Networking Break
Sponsor

Tuesday Afternoon Networking Break
Sponsor

Kaywood Award & Banquet Sponsor



Wednesday Evening Social Hour
Sponsor

Embassy Suites by Hilton Raleigh-Durham Research Triangle

Floor Plan

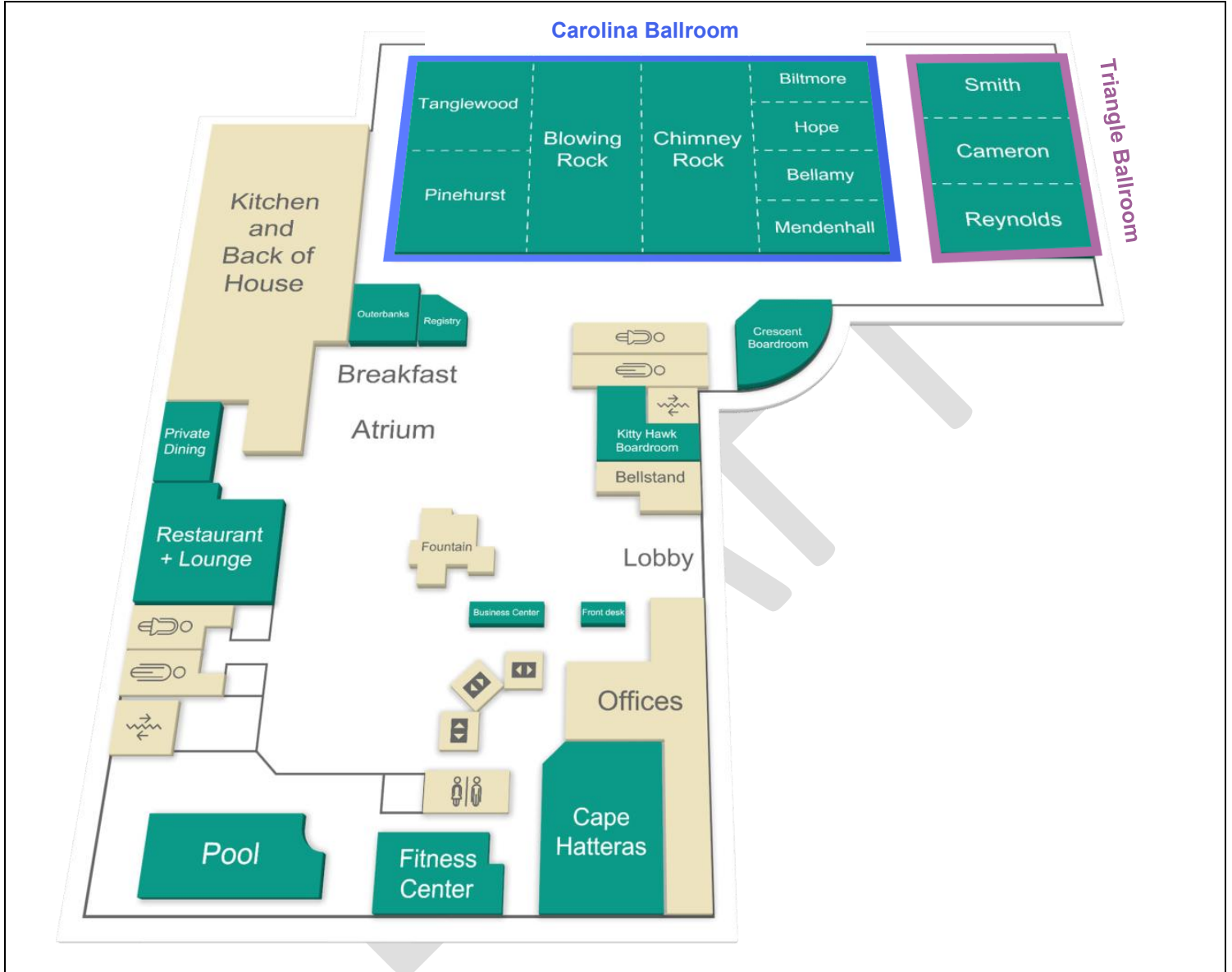

Welcome to the 70th Annual ADTSEA Conference



Saturday July 11, 2026

Time and Location	Event Information
	Breakfast on Your Own
8:00 am – 12:00 pm	Board of Directors' Meeting Presiding: <i>Karl Logan, NC, ADTSEA President</i>
12:00 pm – 1:30 pm	Lunch on Your Own
1:00 pm – 5:00 pm	ADTSEA Conference Registration Pre-registered ADTSEA members may pick up conference materials. <i>Name Badges sponsored by Driver's Ed Solutions, LLC</i> https://www.driversedsolutions.com/ <i>Welcome Bags sponsored</i>
	Dinner on Your Own



DRAFT

Sunday July 12, 2026

Time and Location	Event Information
	Breakfast on Your Own
8:00 am – 5:00 pm	ADTSEA Conference Registration <i>Name Badges sponsored by Driver's Ed Solutions, LLC</i> https://www.driversedsolutions.com/ <i>Welcome Bags sponsored by :</i>
8:30 am – 3:00 pm	State Administrators' Workshop You must be registered at least 2 weeks prior to attending.
8:30 am – 12:00 pm	ADTSEA Conference Workshop #1 How to Teach ADAS In Classroom and BTW <i>Tim Beckham, ADTSEA Project Manager</i>
8:30 am – 12:00 pm	ADTSEA Conference Workshop #2 <i>TBD</i>
12:00 pm – 1:30 pm	Lunch on Your Own
1:30 pm – 5:00 pm	ADTSEA Conference Workshop #3 Best Practices in Supporting Neurodivergent Students in the Classroom and BTW
1:30 pm – 5:00 pm	ADTSEA Conference Workshop #4 Updates to the AAA Curriculum <i>AAA Team</i>
3:30 pm – 5:30 pm	Spouses and Guests Welcome Reception Light refreshments
3:30 pm – 6:30 pm	State and Regional Association Leadership Roundtable and Dinner Limited to 1 representative from each association, President or proxy from each association. Must pre-register at least 2 weeks prior to attending. <i>Dinner Co-Sponsored By:</i>
	 AND 
	Dinner on Your Own



Monday July 13, 2026

Time and Location	Event Information
	Breakfast on Your Own
8:00 am – 3:30 pm	ADTSEA Conference Registration <i>Name Badges sponsored by Driver's Ed Solutions, LLC</i> https://www.driversedsolutions.com/ <i>Welcome Bags sponsored by</i>
8:30 am – 10:00 am	Opening General Session <i>Presiding: Karl Logan, NC, ADTSEA President</i> Presentation of Colors/Pledge of Allegiance <i>Cary JROTC</i> National Anthem <i>Zundrea Baldwin</i> Welcome ADTSEA <i>Karl Logan, NC, ADTSEA President</i> Introduction of ADTSEA Directors and Officers <i>Gary Scott, KS, ADTSEA Secretary/Treasurer</i> Awards Recognition <i>Karl Logan, NC, ADTSEA President</i> Welcome to North Carolina <i>TBD</i> Corporate Member and Exhibitor Recognition <i>Maria Herbert, WI, Drivers Ed Solutions, Inc., Corporate Representative to the ADTSEA Executive Committee</i> Opening Session Presentation <i>Presenter: TBD</i> Announcements <i>Karl Logan, NC, ADTSEA President</i>
10:00 am – 10:30 am	Break on Your Own
General Session 10:30 am – 12:00 pm	What is More Effective in Driver Education Classroom Training: Online, Virtual, and In-person? <i>Teen Panel</i> <i>Presiding: Tim Beckham, ADTSEA Project Manager</i>
12:00 pm – 1:30 pm	Teacher Excellence Award (TEA) Luncheon in Memory of Dr. Francis Kenel & NSSP Awards Recognition <i>Award and Luncheon Sponsored By: The National Road Safety Foundation https://www.nrsf.org/</i>



Monday July 13, 2026

Time and Location	Event Information
Concurrent Session 1:30 pm – 3:00 pm	2026 Teacher Excellence Award Recipient Presentations TBD <i>TBD</i>
	How to be a Better Leader and Role Model for your Students <i>ADTSEA Education and Training Committee</i> <i>Presiding: Michael Jones, Sr., NC, Chairperson, ADTSEA Education and Training Committee</i>
Concurrent Session 1:30 pm – 3:00 pm	2025 Study: How Simple Prompts can Make Partially Automated Cars Safer <i>North Carolina State University</i> <i>Presiding: William Van Tassel, Chairperson, ADTSEA Research Committee</i>
2:00 pm – 5:00 pm	Exhibitor Setup <i>Coordinators: Leslie Robinson, ADTSEA; Maria Herbert, WI, Drivers Ed Solutions, Inc., Corporate Representative to the ADTSEA Executive Committee</i>
3:00 pm – 3:30 pm	Break on Your Own
Concurrent Session 3:30 pm – 5:00 pm	2026 Teacher Excellence Award Recipient Presentations <i>TBD</i> How Topics Interlace with Each Other in a Driver Education Curriculum <i>ADTSEA Education and Training Committee</i> <i>Presiding: Michael Jones, Sr., NC, Chairperson, ADTSEA Education and Training Committee</i>
Concurrent Session 3:30 pm – 5:00 pm	Research Updates on Driver Education <i>Johnathon Eshani, John Hopkins University</i> <i>Michael Wagner, Delaware</i> <i>Presiding: Audra Urie, UT, Chairperson, ADTSEA Administration and Oversight Committee</i>
5:30 pm – 6:00 pm	ADTSEA Exhibit Opening and Exhibitor Showcase 
6:00 pm – 7:00 pm	Welcome Reception with Exhibitors Light refreshments
	Dinner on Your Own

Tuesday, July 14, 2026

Time and Location	Event Information
	Breakfast on Your Own
7:00 am – 8:30 am	Past Presidents' Roundtable/Meeting Presiding: <i>Jennifer Sletten, MN, ADTSEA Past President</i>
8:00 am – 3:30 pm	ADTSEA Conference Registration <i>Name Badges sponsored by Driver's Ed Solutions, LLC</i> https://www.driversedsolutions.com/ <i>Welcome Bags sponsored by</i>
	
8:00 am – 5:00 pm	Exhibits Open
	
Concurrent Session 8:30 am– 10:00 am	Roundtable Discussions on Current Issues in Driver Education <i>ADTSEA Education and Training Committee</i> <i>Presiding: Michael Jones, Sr., NC, Chairperson, ADTSEA Education and Training Committee</i>
Concurrent Session 8:30 am – 10:00 am	Behavioral Traffic Safety Cooperative Research Program <i>Johnathon Ehsani, Johns Hopkins University</i> <i>Presiding: William Van Tassel, Ph.D., Chairperson, ADTSEA Research Committee</i>
10:00 am – 10:30 am	Networking Break with Exhibitors Light refreshments
	
Concurrent Session 10:30 am – 12:00 pm	Artificial Intelligence How it is Helpful and Where it Can be Detrimental <i>TBD</i> Consumer Protection: What it Means and How to Protect Your Program <i>North Carolina Attorney General</i> <i>Presiding: Audra Urie, UT, Chairperson, ADTSEA Administration and Oversight Committee</i>
Concurrent Session 10:30 am – 12:00 pm	How to Protect Your Program <i>TBD</i> How to Effectively Advertise Your Company <i>TBD</i> <i>Presiding: Michael Jones, Sr., NC, Chairperson, ADTSEA Education and Training Committee</i>
12:00 pm – 1:30 pm	Lunch <i>Sponsored by:</i>
General Session 1:30 pm – 2:30 pm	Bishop Forum <i>TBD</i> <i>TBD</i> <i>Presiding: Allyn Workman, MO, ADTSEA President Elect</i> <i>Sponsored By: ADTSEA Member Donations and ADTSEA Lapel Pin Sales</i>
2:30 pm – 3:00 pm	Networking Break with Exhibitors Light refreshments

Tuesday, July 14, 2026

Time and Location	Event Information
3:00 pm – 4:30 pm	Regional Meetings Presiding: ADTSEA Board of Directors All attendees are encouraged to participate in their region’s meeting.
Region	
Northeast Region	
Southeast Region	
Central Region	
West Region	





Board Buses at 5:00 pm Depart for venue 5:15 pm	Outing: Bowling Night! Bowlero Raleigh : Buffet dinner, bowling and arcade
--	--

Notes:



Wednesday July 15, 2026

Time and Location	Event Information
	Breakfast on Your Own
7:30 am – 8:15 am	Board of Directors' Meeting Presiding: <i>Jennifer Sletten, MN, ADTSEA President</i>
8:00 am – 3:30 pm	ADTSEA Conference Registration <i>Name Badges sponsored by Driver's Ed Solutions, LLC</i> https://www.driversedsolutions.com/ <i>Welcome Bags sponsored by</i>
	
8:00 am – 10:30 am	Exhibits Open
	
Concurrent Session 8:30 am – 10:00 am	Strategies to Improve Your Parent Seminars <i>TBD</i> <i>Presiding: Michael Jones, Sr., NC, Chairperson, ADTSEA Education and Training Committee</i>
Concurrent Session 8:30 am – 10:00 am	Effects of the National Safe Roads Challenge Program on Safe Driving Behaviors <i>TBD</i> <i>Presiding: William Van Tassel, Ph.D., Chairperson, ADTSEA Research Committee</i>
10:00 am – 10:30 am	Networking Break with Exhibitors Light refreshments
	
10:30 am – 11:30 am	Corporate Member and Exhibitor Roundtable Presiding: <i>Maria Herbert, WI, Drivers Ed Solutions, Inc., Corporate Representative to the ADTSEA Executive Committee</i>
Concurrent Session 10:30 am – 12:00 pm	Behind-the Wheel Evaluation <i>TBD</i> Strategies to Include the Observing Students <i>ADTSEA Education and Training Committee</i> <i>Presiding: Michael Jones, Sr., NC, Chairperson, ADTSEA Education and Training Committee</i>
Concurrent Session 10:30 am – 12:00 pm	The Importance of Mental Health to Make Your State Program Stronger <i>TBD</i> <i>Presiding: Audra Urie, UT, Chairperson, ADTSEA Administration and Oversight Committee</i>
11:30 am – 2:00 pm	Exhibitor Breakdown
12:00 pm – 1:30 pm	Lunch on Your Own

Wednesday July 15, 2026

Time and Location	Event Information
Concurrent Session 1:30 pm – 3:00 pm	Sharing the Road with Different Roadway Users <i>TBD</i>
	The Importance of a Quality Driver Education <i>Jackie Milani, MS, MBA, Highway Safety Specialist, NHTSA</i> <i>Presiding: Michael Jones, Sr., NC, Chairperson, ADTSEA Education and Training Committee</i>
Concurrent Session 1:30 pm – 3:00 pm	<i>Update on Vehicle Technologies: What's New, What Are People Willing to Pay for, and How Effective are Today's Technologies</i> <i>Dr. William Van Tassel, AAA</i> <i>Ned Ferris, AAA</i> <i>Presiding: William Van Tassel, Ph.D., Chairperson, ADTSEA Research Committee</i>
3:15 pm – 4:45 pm	ADTSEA Annual Business Meeting, Installation of Regional Board of Directors, and Constitution and Bylaws Amendments <i>Presiding: Karl Logan, NC, ADTSEA President</i> All members are encouraged to attend Separate Agenda and Meeting Packet provided at meeting
5:30 pm Dinner	ADTSEA Closing Ceremonies, Installation of Officers, and Banquet *Banquet Ticket Required Master of Ceremonies and Induction Facilitator: Induction of Executive Committee Presentation of Kaywood Award Invocation Dinner Service 2027 ADTSEA Conference – TBD <i>Kaywood Award and Banquet Sponsored by:</i> <u>AAA National – Driver Training</u>
8:00 – 10:00 pm	ADTSEA After Banquet Social Hour <i>Sponsored by:</i>



Notes:



Welcome 2026 Exhibitors



Established in 1902, **AAA** provides safety and security to more than 62 million members across North America. Since creating the first driver education curriculum in 1935, AAA has been a leader and advocate for safe mobility. Our How to Drive curriculum, now in its 15th edition, is the only officially endorsed curriculum by ADTSEA and meets ADTSEA's strict standards for both content and delivery.

For more information, contact:
Mike Keesee
mkeesee@national.aaa.com

AAA National Office



The Association for Driver Rehabilitation Specialists (ADED), a 501(c)(3) nonprofit, promotes safe and independent community mobility. ADED's professional members assist drivers with disabilities and aging. ADED has created a Best Practice Guidelines for the Provision of Driver Rehabilitation Services publication and is the only organization to offer the Certified Driver Rehabilitation Specialist (CDRS) certification, and the Driver Rehabilitation Professional (DRP) micro credential. Especially with the driving instructor/trainer in mind, ADED also offers a Specialized Instructor Badge, a curriculum-based pathway that provides education and mentorship for training drivers with disabilities. ADED offers its members continuing education, networking, mentoring, and a quarterly newsletter. Non-members and those interested in working in the field of driver rehabilitation are welcome to attend ADED courses, workshops, and annual conference.

<https://www.aded.net/>



Imagine how much simpler your life would be if you didn't have to... register students for classes, schedule/cancel/reschedule drive times, send reminders, take payments, fill out state forms... Let your website automate these tasks and many more. Parents and students will love selecting drive times. Instructors will love managing their schedules. And you? Because you've eliminated the busy work, you'll love spending more time on the important things.

Over the past 12 years, we've transformed hundreds of driver ed businesses across the US and Canada with our robust driving school management software. Whether you're a school with 20,000 or 200 students, you'll receive the same exemplary service that all of our customers appreciate.

Become part of the ever growing DES family. Schedule a demo today at www.driversedsolutions.com.



The National Road Safety Foundation, Inc. (NRSF) is a non-profit charitable organization that has been dedicated to reducing crashes, deaths, and injuries on our nation's highways by promoting safe driving habits through greater public awareness for over 60 years.

NRSF produces documentaries, educational resources, and public service campaigns for use in safety, educational and enforcement programs by police, teachers, traffic safety agencies, healthcare professionals, youth advocacy groups and other government and grass-roots agencies. NRSF free resources deal with distracted driving, speed and aggression, impaired driving, drowsy driving, driver proficiency and pedestrian safety. The Foundation also works with youth advocacy groups and sponsors contests to engage teens in promoting safe driving to their peers and in their communities.

For information or to download free resources, visit <https://www.nrsf.org/>.

Richard Kaywood Memorial Award

Beginning in 1985, and each year thereafter at the annual ADTSEA conference, an award is presented to an individual for outstanding contributions to traffic safety in memory of Dr. Richard Kaywood, who served the Association and traffic safety education for many years. This award is sponsored cooperatively with AAA Traffic Safety.

Dick had a long and productive career, beginning with his work in safety education as an assistant professor of health and physical education at the University of California at Santa Barbara. In 1955, he became the multi-school chairman of driver education in the Anaheim Union High School District. In 1965, he became an associate professor of driver and traffic safety education at California State University at Long Beach. He went on to become a full professor and coordinator of safety and driver education. During his last three years, he also served as interim chairperson of the health science department.

Throughout his life, Dick was a tireless worker and strong advocate for quality driver and traffic safety education programs. Dick Kaywood's life exemplifies the spirit of the words inscribed on the Richard Kaywood Award medallion: Outstanding Contribution – Driver and Traffic Safety Education.

Kaywood Award Recipients

William Cushman	1985	Owen Crabb	2006
Dr. Norman Key	1986	Dr. Allen Robinson	2007
Amos Neyhart	1987	Margaret Johnson	2008
Dr. Robert Marshall	1988	Barbara Brody	2009
Dr. Richard Bishop	1989	Dr. Dale Ritzel	2010
Warren Hastings	1990	Janice Meeker	2011
Dr. Frank Kenel	1991	Randall Thiel	2012
Dr. James Aaron	1992	Carol Hardin	2013
Art Opfer	1993	Lindsay Townsend	2014
Carl Wenzinger	1994	Gary Guzouskas	2015
"Doc" Whitworth	1995	Chuck Lehning	2016
Joe Intorre	1996	Dr. Frank Gruber	2017
Warren Quensel	1997	Connie Sessoms, Jr.	2018
Dr. John Palmer	1998	Richard Hanson	2019
Dr. Gary Bloomfield	1999	Jerry Gaines	2020
George E. Tyson	2000	Dr. Nina Jo Saint	2021
Dr. Bob Gustafson	2001	Robin Bordner	2022
Fred Mottola	2002	Dr. William Van Tassel	2023
Dr. Maurice Dennis	2003	Mark Lee	2024
Dr. Terry Kline	2004	Audra Urie	2025
John Harvey	2005		



ADTSEA Teacher Excellence Award

In Honor of Dr. Francis Kenel

The American Driver and Traffic Safety Education Association's (ADTSEA) Teacher Excellence Award (TEA) sponsored by The National Road Safety Foundation (NRSF), honors outstanding driver and traffic safety educators.

Dr. Kenel worked as an Industrial Engineer in Traffic Safety and was the National Director of the American Automobile Association for Highway and Traffic Safety. He was a member of the American Driver and Traffic Safety Education Association and taught at the University of Maryland at College Park, Illinois State University in Normal, Illinois and Michigan State University in East Lansing, MI. He also worked with the Illinois High School and College Driver Education Association. He was a Consultant for Brazil and Portugal, engineering their road systems and traveled all over the United States as a Police Pursuit Instructor.

Dr. Francis Kenel was a mentor to many driver education teachers. He authored materials on teacher training and beginning driver education. Dr. Kenel was a constant resource to the ADTSEA staff, officers, and members.

ADTSEA Teacher Excellence Award Recipients

Robin A. Bordner, MI	1999	Fred Schreiber, MN	2010	Darin Bardal, ND	2019
Duane L. "Dewey" Mettler, MN	2000	Michael Shepherd, WA	2010	Stanley A. Blicharz, VT	2019
Chuck Filippini, WA	2001	Charles Worrell, VT	2010	Robert Droege, MO	2019
Lindsay Townsend, VT	2002	Barbara Brody, VT	2011	Michael Ray Jones, Sr., NC	2019
Debbie Cottonware, WA	2003	Bobby Duque, HI	2011	Raymond F. Kroll, MN	2019
John Knippel, CA	2004	Gerald Apple, WA	2012	George Rooney, VT	2020
Harold Lair, MT	2005	Kevin Masse, VT	2012	Jorge Benitez, NC	2020
Richard Hanson, OR	2006	Richard Salboro, HI	2012	Wayne Hartman, IL	2020
Mark Lee, MN	2006	Rachel Wilson, MI	2012	Molly Kleiber, MO	2020
Greg Brown, MI	2007	Mark Hamilton, VT	2013	Tim Beckham, OR	2020
John Duffy, VA	2007	Christine Bergan, WI	2013	Joell Kerr, HI	2021
William Mayville, VT	2007	Carol Hoormann, MO	2014	Karren Meyer, VT	2021
Joseph Christensen, MN	2007	Beatrice Kehr, MN	2014	Robert Suggs, SC	2021
Joe Barch, VT	2008	John F. Viau, VT	2014	Alex Hansen, WA	2022
David Barnum, MN	2008	Rod Hull, NH	2015	Richard Kearney, VT	2022
Donn Davidson, MI	2008	Greg Mangan, TN	2015	Tom Iffrig, MO	2022
Gary Davis, NC	2008	Carlos Stalcup, NC	2015	Jennifer Sletten, MN	2022
Romona Cook, TX	2008	Becky Hardy, ND	2016	JoEllen Suter, VA	2022
Warren Hisashi Miyasaki, HI	2008	Yusuf Quidwai, WA	2016	Sandra Dunbar, NC	2023
William "Bill" Warner, OR	2008	Judy Weber-Jones, IL	2016	Gary Scott, KS	2023
Sammy Lee, HI	2009	Cynthia Bagley, HI	2017	Jennifer Brown, IL	2024
Larry Fosness, MN	2009	Jonathon Dondoneau, ND	2017	Deborah Fry, VA	2024
John Lynch, VT	2009	Larry Fairclo, OR	2017	Gabriella Netsch, VT	2024
Charles Mason, NC	2009	Allyn Workman, MO	2017	Jim Carroll, MT	2025
Stan Henderson, IN	2010	Kel Hirohata, HI	2018	Duane Kjono, MN	2025
William Powell, NC	2010	Andrew Unseth, MN	2018	Paul McNamara, MA	2025
Gay Ching, HI	2010	Susan Carney Lammerding, MT	2018	Oscar Outen, NC	2025
Gerald Dickinson, TX	2010	Dale Ludwig, ND	2018		
Kevin Kirby, WI	2010	Richard Ritter, VT	2018		

ADTSEA Past Presidents

Year	Past Presidents	Conference Location	Year	Past Presidents	Conference Location
1957-1958	Robert Marshall, MO	Boulder, CO	1991-1992	Gene Wilkins, TX	Atlanta, GA
1958-1959	Joseph V. Intorre, PA *	Lansing, MI	1992-1993	John Palmer, MN	Novi, MI
1959-1960	Lawton K. Smith, MI *	San Jose, CA	1993-1994	Percy Benedict, OR *	Burlington, VT
1960-1961	Joseph W. Nelson, OR	Miami, FL	1994-1995	Barbara Brody, VT	Huntsville, AL
1961-1962	Donald L. Healy, KS	Lawrence, KS	1995-1996	Bob Sundermeier, CO	Grand Junction, CO
1962-1963	John S. Urlaub, CA	Charleston, WV	1996-1997	C. E. Welch, IL *	St. Cloud, MN
1963-1964	H. Edward Williamson, FL	Seattle, WA	1997-1998	Gerry Apple, WA	Springfield, IL
1964-1965	Lonnie Gilliland, OK *	Grossinger, NY	1998-1999	Jim Lewis, CA	San Diego, CA
1965-1966	Truman S. Smith, MN	Madison, WI	1999-2000	Gary Guzouskas, NH	Billings, MT
1966-1967	Melvin T. Schroeder, CA *	Springfield, MO	2000-2001	Marty Rossini, MN	Nashua, NH
1967-1968	Richard D. Ellis, NY	Pocatello, ID	2001-2002	Patricia Houston, OR	Overland Park, KS
1968-1969	James E. Aaron, IL *	Ypsillanti, MI	2002-2003	Kal Kelliher, GA	Charlotte, NC
1969-1970	Clifford Boyce, WA *	Atlanta, GA	2003-2004	Randy Thiel, WI	Portland, OR
1970-1971	Henry A. Vaughn, OK *		2004-2005	Elizabeth Weaver Shepard, ID	Honolulu, HI
	Philip J. O'Leary, MI *	Springfield, IL	2005-2006	Jim Gibb, MO *	Kalamazoo, MI
1971-1972	Philip J. O'Leary, MI *	Fort Worth, TX	2006-2007	Carol Hardin, VA	Burlington, VT
1972-1973	Cissie E. Gieda, MD *	San Diego, CA	2007-2008	Gary Scott, KS	Fort Worth, TX
1973-1974	J. B. Angelo Crowe, GA	Denver, CO	2008-2009	Roger Voigt, IL	Charlotte, NC
1974-1975	Robert A. Ulrich, MO	Warrensburg, MO	2009-2010	Chuck Lehnig, NC	St. Louis, MO
1975-1976	Neal H. Rathjen, WI	Miami, FL	2010-2011	Fred Nagao, HI	Honolulu, HI
1976-1977	Donn W. Maryott, NY	Milwaukee, WI	2011-2012	Kevin Kirby, WI	Appleton, WI
1977-1978	Allan E. Cafferty, ID *	Seattle, WA	2012-2013	Connie Sessoms, Jr., NC	Portland, ME
1978-1979	Jay M. Smith, AZ *	Charlotte, NC	2013-2014	Connie Sessoms, Jr., NC	Wichita, KS
1979-1980	Donald L. Smith, MI *	Columbus, OH	2014-2015	Cathy Broderick, VT	Raleigh, NC
1980-1981	Charles L. McDaniel, NC *	Albuquerque, NM	2015-2016	Jan Meeker, HI	Portland, OR
1981-1982	David C. Lawson, OR	Baltimore, MD	2016-2017	Reginald Flythe, NC	Sacramento, CA
1982-1983	I. Russell Hutter, WI	El Paso, TX	2017-2018	Wendy Bills, UT	Rosemont, IL
1983-1984	Maurice Dennis, TX	Chicago, IL	2018-2019	Mark Lee, MN	Burlington, VT
1984-1985	Owen L. Crabb, MD	Norfolk, VA	2019-2020	William Van Tassel, Ph.D., FL	Virtual Conference
1985-1986	Willis Valett, WI *	St. Paul, MN	2020-2021	William Van Tassel, Ph.D., FL	Knoxville, TN
1986-1987	Gary J. Bloomfield, WA	Spokane, WA	2021-2022	William Warner, OR	Vancouver, WA
1987-1988	Billy G. Johnson, VA	Boston, MA	2022-2023	Joseph Barch, VT	Wichita, KS
1988-1989	Robert L. Freeman, MO	Las Vegas, NV	2023-2024	Harold Fleming, NC	Albany, NY
1989-1990	Dennis Caughney, MN	Portland, OR	2024-2025	Jen Sletten, MN	Billings, MT
1990-1991	John Harvey, WA *	San Antonio, TX	2025-2025	Karl Logan, NC	Raleigh, NC

**Denotes deceased Past Presidents*

ADTSEA Executive Committee

Karl Logan, NC	President	Allyn Workman, MO	President-Elect
Jennifer Sletten, MN	Past President	Gary Scott, KS	Secretary Treasurer
Tricia Carson-Myers, NC	Board Representative	David Reich, NY	Corporate Representative
Maria Herbert, WI	Corporate Representative		

ADTSEA Board of Directors

Northeast		Central	
Michael Wagner, DE	2023 - 2026	Jon Dondoneau, ND	2025 - 2026
Richard Kearney, VT	2024 - 2027	Andy Nelson, IA	2024 - 2027
Paul McNamara, MA	2025 - 2028	Rachel Wilson, MI	2025 - 2028
Southeast		West	
Tricia Myers, NC	2023 - 2026	Travis Gordon, OR	2023 - 2026
Derek Stewart, FL	2024 - 2027	Blain Roberts, UT	2024 - 2027
Robert Suggs, NC	2025 - 2028	Gerald Apple, WA	2025 - 2028

ADTSEA Committee Chairpersons

Administration	Audra Urie, UT	Constitution & Bylaws	Connie Sessoms Jr., NC
Education & Training	Michael Jones, Sr., NC	Curriculum Standards	Robin Bordner, MI
Research	William Van Tassel, Ph.D., FL	Teacher Excellence Award	Harold Fleming, NC

Affiliated State Associations

Florida	Georgia	Idaho	Illinois	Iowa
Kansas	Michigan	Minnesota	Missouri	Montana
Nebraska	New Hampshire	New York	North Carolina	North Dakota
Pennsylvania	South Carolina	South Dakota	Tennessee	Utah
Vermont	Virginia	Washington	West Virginia	Wisconsin

ADTSEA Institutional Members

A & A Driving School/ Drivers Rehabilitation Center of Michigan	A+ Academy Driving School, LLC, TX	A+ Mom's Driving School, KY
AAA Driving School, NH	All Seasons Driving School, WA	Benson Driving School, LLC, NC
Bradburys Driving, MA	Decisive Driver LLC, OK	Drive4Life Academy, TN
Drivers R Us Driver Education, ID	Driving Academy of Northwest Arkansas	Eastern Lebanon County High School, PA
Elite Steering Driving School, ND	Excelsior International Driving Academy, CO	Frazier School District, PA
Hawkeye Community College Regional Transportation Training Center, IA	Haywood County Schools, NC	International Driving School, LLC, WA
Ithaca High School, MY	Johnson County Community College, KS	Jordan Driving School, NC
Juab High School, UT	KS International Drivers Ed	Michigan Driving School North
Midwest Truck Driving School, MI	Mifflinburg Area School District, PA	Negaunee public Schools, MI
New Direction Driving School, OH	Newport County Driving School, RI	OESJ Central School District, NY
Pelican Rapids Public Schools, MN	River City Driving School, VA	Safer Driver Solutions, IA
Spaulding High School, VT	St. Cloud State University, MN	Start Right Driving School LLC, FL
Thompson Driving School, AR	Universal Driving School, LLC, AZ	Utah State Board of Education

Thank You ADTSEA Corporate Members:

ADTSEA Corporate Partners



ADTSEA Corporate Colleagues



ADTSEA Corporate Associate



ADTSEA Corporate Friends



ADTSEA Corporate Non-Profits & Associations

